

Math 474:  
Tropical Geometry  
Spring 2021  
Professor Ralph Morrison  
TAs: Robin Huang and Liza Jacoby

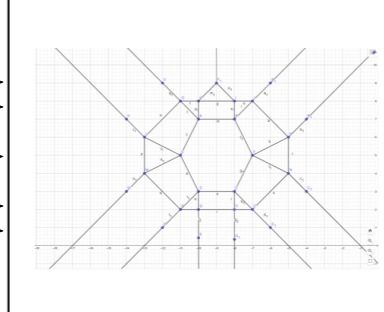
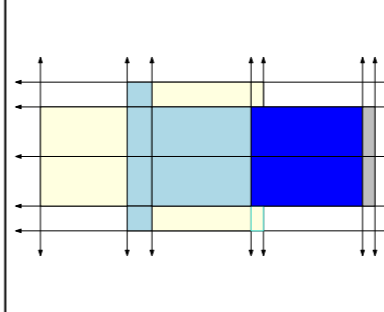
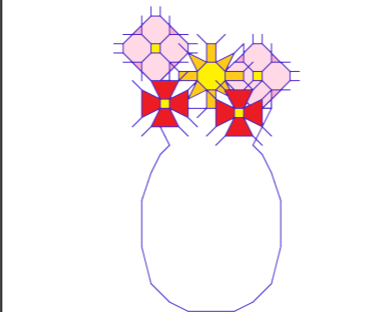
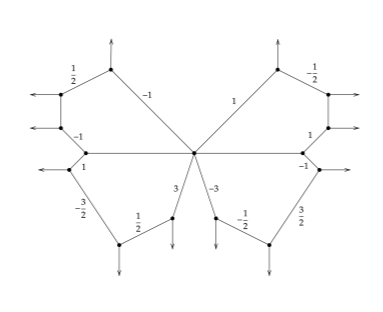
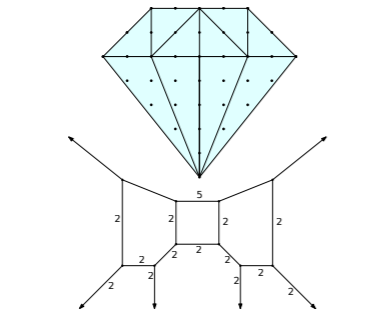
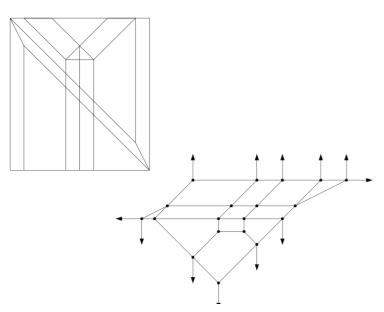
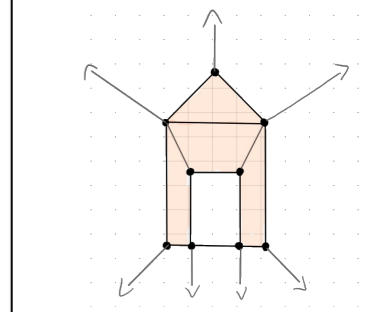
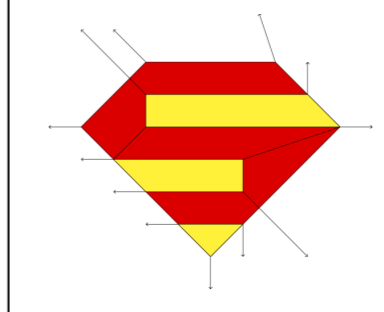
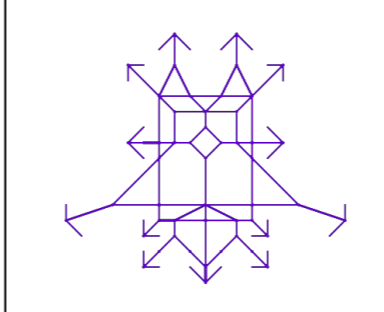
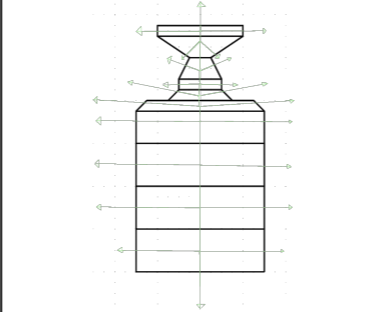
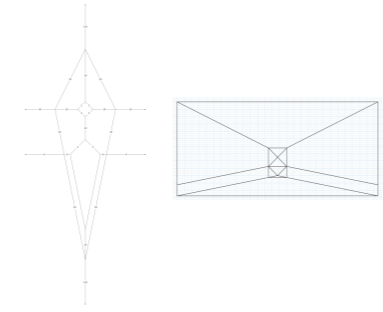
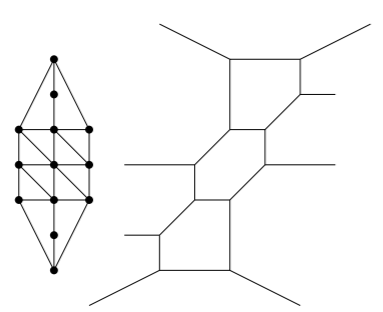
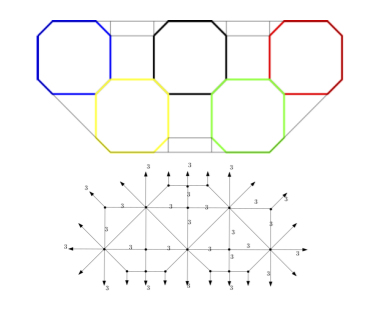
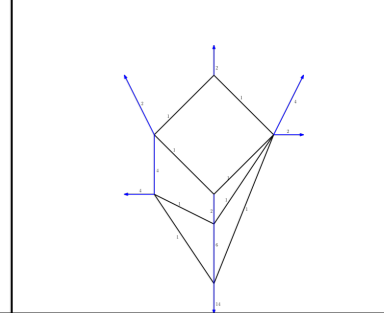
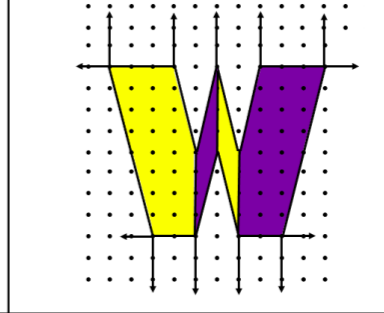
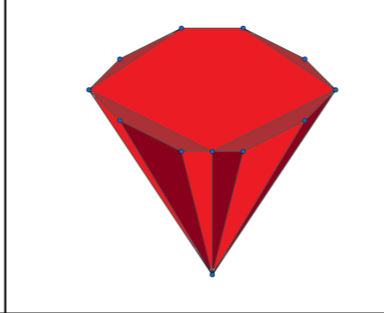
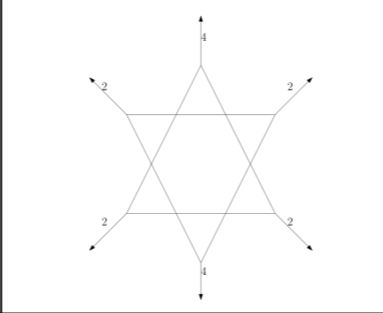
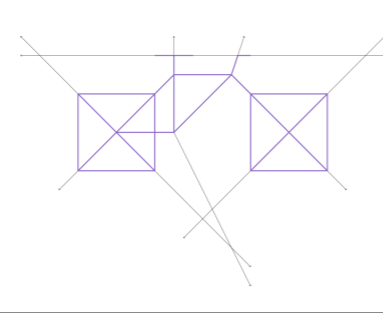
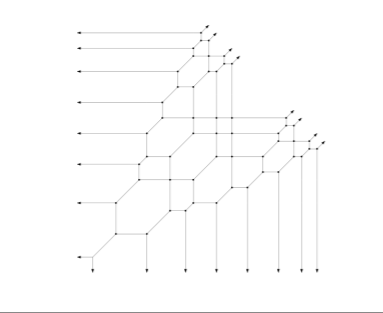
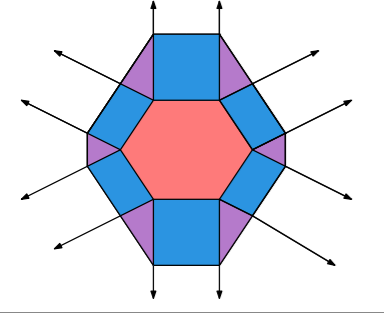
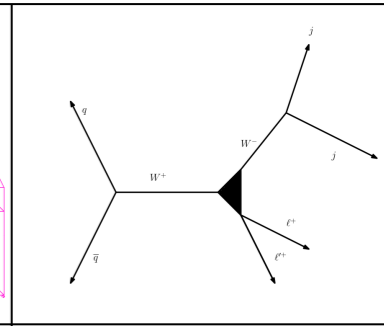
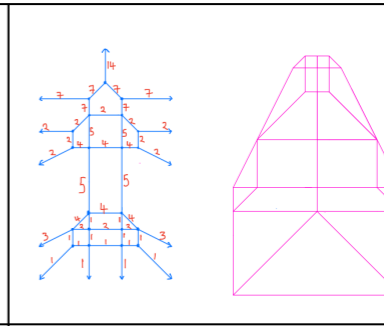
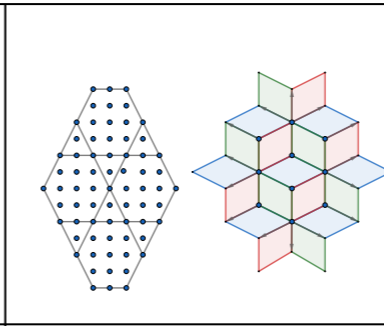
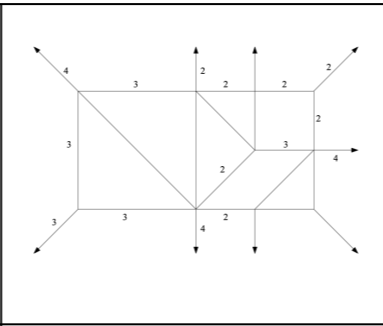
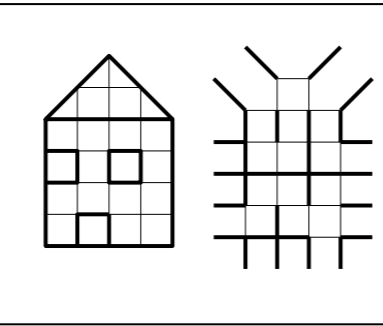
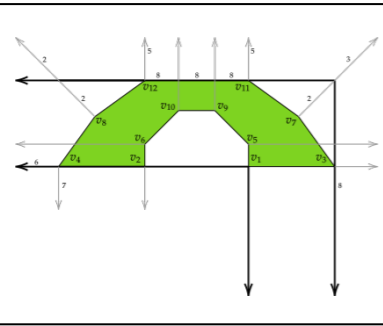

Tropical curves by:

Benjamin Baily, Austin Barr, Erica Barrett,  
Jackson Bibbens, Felix Biwott, Snehadri Das,  
Adam Dionne, Markus Feng, Emil Graf,  
Michael Greenberg, Brian Ha, Meghan Halloran,  
Ben Kitchen, Alex Kitt, Patrick Lang,  
Matthew Lindheim-Marx, Cory Lund, Eli Miller,  
Clayton Mizgerd, Novera Rahman Momo,  
Alexander Paolozzi, Daniel Renwick,  
Maria Rodriguez-Hertz, Sarah Shi, Stephen Willis,  
and Tony Zhang